

产品规格书

产品类型 插座(JACK)
Product type _____

产品型号 MJ4F2C
Product NO. _____

客户名称
Customer _____

生产方	核准 (APPROVAL)	审核 (AUDIT)	制作 (COMPILE)
Manufacturer			

客户方	核准 (APPROVAL)	审核 (AUDIT)	承认 (ACCEPT)
(Customer)			

一、MJ4F2C 产品外观 (Product Appearance)



二、产品特性 (Product features)

- ☑ 坚固的全金属外壳，可提供最佳保护 (All metal housing offers best overall protection)
- ☑ 双接地设计 (Duplex ground contact)
- ☑ 可选 1 号针同外壳接地轻松连接 (Optional connection to easily join pin 1 to chassis ground)
- ☑ 标准的 D 型安装尺寸 (Standard D mounting dimensions)

三、技术参数 (Technical parameters)

1. 电气参数 (Electrical parameters)

触点间电容 (Capacitance between contacts)	$\leq 7\text{pF}$
触点电阻 (Contact resistance)	$\leq 5\text{m}\Omega$
介电强度 (Dielectric strength)	1500V DC
绝缘电阻 (Insulation resistance)	$> 10\text{G}\Omega$ (initial)
每位额定电流 (Rated current per contact)	10A
额定电压 (Rated voltage)	$< 50\text{V}$

2. 机械参数 (Mechanical parameters)

插入压力 (Insertion force)	$\leq 20\text{N}$
拔出压力 (Withdrawal force)	$\leq 20\text{N}$
使用寿命 (Service life)	> 1000 mating cycles
锁定装置 (Locking device)	Latch lock
底座外形 (Chassis shape)	D

3. 材料和环境 (Material and environmental parameters)

触点电镀 (Contact plating)	Ag
触点 (Contacts)	Copper alloy
内芯 (Insert)	Polyamide (PA66 +30%GF)
外壳 (Shell)	Zinc diecast (ZnAl4Cu1)
外壳电镀 (Shell plating)	Pearl chrome
阻燃等级 (Flame-retardant grade)	UL94 V0
保护等级 (Protection class)	IP 40
可焊性 (Solderability)	Complies with IEC 68-2-20
使用温度范围 (Temperature range)	-30°C to +80°C

4. 标准和规范 (Standard)

标准 (Standard)	IEC 61076-2-103
---------------	-----------------

四、产品外形尺寸 (Product Profile)

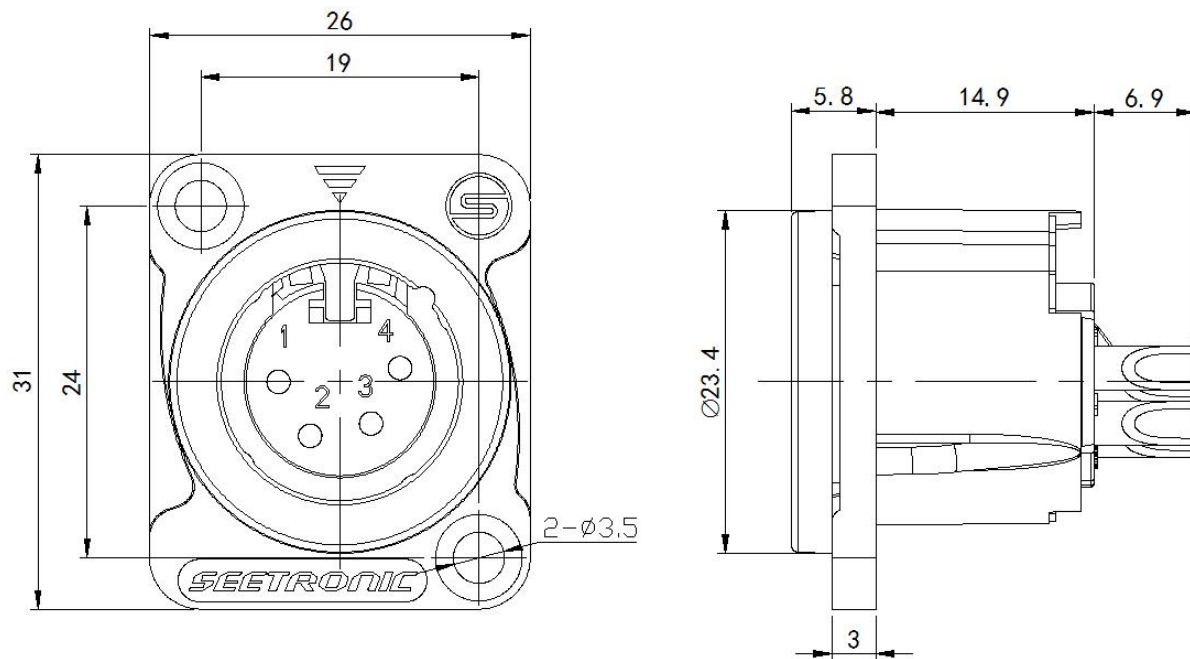

安装开孔尺寸

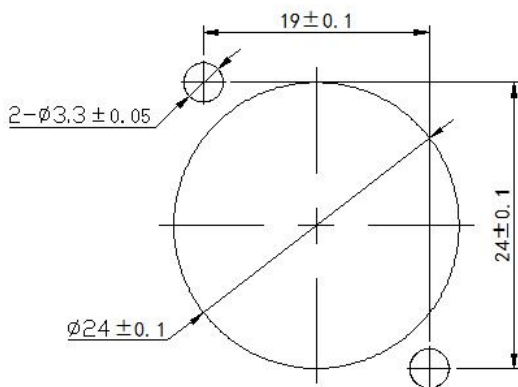

单位: mm

五、安装使用说明 (Installation instructions)

面板安装 (Panel mount): 前端和后端 (Front and rear)